

**Submittal Data: VIR12HP115V1A 12,000 BTU/H (115V) Wall Mounted Heat Pump System**

Job Name \_\_\_\_\_ Location \_\_\_\_\_ Date \_\_\_\_\_

Purchaser \_\_\_\_\_ Engineer \_\_\_\_\_

Submitted To \_\_\_\_\_ For  Reference  Approval  Construction

Unit Designation \_\_\_\_\_ Schedule No. \_\_\_\_\_

- GENERAL FEATURES**
- Compact and Quiet Design
  - High Efficiency DC Inverter Technology
  - Vertical Swing Louver
  - Wireless Remote with LCD Display
  - Wired Tether Controller ( Sold Separately)
  - Low Ambient Cool to 0 deg F
  - Gold Fin Condenser Coil
  - 5 year Limited Parts Warranty
  - 7 year Limited Compressor Warranty



**System Ratings Indoor Unit Data**

System Ratings		
<b>Cooling</b>		
Rated Capacity		12,000 BTU/H
Capacity Range		3,414-14,569 BTU/H
Power Input (Max)		1,300 W
SEER		22.0
EER		12.5
<b>Heating at 47° F</b>		
Rated Capacity		12,200 BTU/H
Capacity Range		2,764-16,582 BTU/H
Power Input (Max)		1,3500 W
HSPF		10.2
COP		3.6
<b>Heating at 17° F</b>		
Rated Capacity		7,821 BTU/H
<b>Operating Range</b>		
Cooling	(Max)	115°F (46 C)
	(Min)	0°F (-18 C)
Heating	(Max)	75°F (24 C)
	(Min)	-4°F (-20 C)

Indoor Unit Data		
Fan Motor	Type	Cross-Flow
	Output Power	40 W
	FLA	0.3 A
<b>Airflow</b>		
Cooling	Wet (Lo/Hi)	171/400 CFM
Heating	Dry (Lo/Hi)	171/400 CFM
<b>Sound Pressure Level</b>		
Cooling	(Min/Max)	28/45 db(A)
Heating	(Min/Max)	28/45 db(A)
Dehumidification		2.96 pt/hr

**Refrigerant Piping Data Outdoor Unit Data**

Gas Pipe Size (OD)		1/2-in
Liquid Pipe Size (OD)		1/4-in
Connection Method		Flared
MAX Refrigerant Pipe Length		66-ft
MIN Refrigerant Pipe Length		10-ft
MAX Refrigerant Pipe Elevation		33-ft

Compressor	Type	DC Inverter Driven Rotary
	RLA	12.5 A
Refrigerant Type		R410A
Fan Motor	Output Power	30 W
	FLA	0.55 A
<b>Sound Pressure</b>		
Cooling/Heating		53/53 db(A)
<b>Power Supply</b>		
Normal Operational Voltage		115 V, 1 Phase, 60 Hz
Voltage Range		103 - 127 V
MCA		17.0 A
MOCP/Breaker Size		25 A

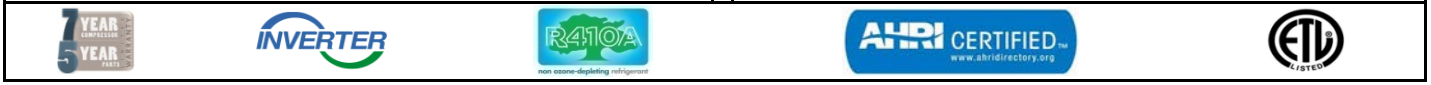

**COOLING PERFORMANCE (BtuH)\***

Outdoor Ambient DB	Indoor Ambient Temperature							
	68F DB (20C)		73F DB (23C)		80F DB (27C)		82F DB (28C)	
	57F WB (14C)		61F WB (16C)		67F WB (19C)		68F WB (20C)	
	TC	SHC	TC	SHC	TC	SHC	TC	SHC
5°F	7,656	6,005	8,088	6,341	9,128	7,159	9,508	7,458
14°F	7,852	6,159	8,292	6,503	9,476	7,431	9,871	7,740
23°F	8,388	6,580	8,972	7,038	10,280	8,063	10,708	8,399
32°F	10,172	7,978	10,880	8,533	11,916	9,343	12,413	9,732
41°F	11,520	9,035	12,240	9,598	13,080	10,259	13,625	10,686
50°F	11,384	8,930	12,108	9,497	12,960	10,166	13,500	10,589
59°F	11,104	8,707	11,824	9,274	12,840	10,072	13,375	10,492
68°F	10,824	8,488	11,544	9,055	12,600	9,882	13,125	10,294
77°F	10,548	8,273	11,264	8,833	12,360	9,696	12,875	10,100
86°F	10,244	8,034	10,960	8,594	12,000	9,412	12,500	9,804
95°F	9,996	7,840	10,708	8,399	11,844	9,290	12,338	9,678
104°F	9,748	7,645	10,460	8,205	11,688	9,169	12,175	9,551
113°F	9,248	7,252	9,960	7,812	11,192	8,776	11,658	9,142

**HEATING PERFORMANCE (BtuH)\***

Outdoor Ambient DB	Indoor Ambient Temperature							
	68F DB (20C)		73F DB (23C)		80F DB (27C)		86F DB (30C)	
	57F WB (14C)		61F WB (16C)		67F WB (19C)		72F WB (22C)	
	TC	SHC	TC	SHC	TC	SHC	TC	SHC
-4°F	6,401	6,401	6,340	6,340	6,233	6,233	5,982	5,982
0°F	6,935	6,935	6,870	6,870	6,756	6,756	6,477	6,477
6°F	7,316	7,316	7,248	7,248	7,126	7,126	6,832	6,832
10°F	7,621	7,621	7,549	7,549	7,423	7,423	7,118	7,118
16°F	7,850	7,850	7,778	7,778	7,648	7,648	7,331	7,331
19°F	8,006	8,006	7,926	7,926	7,797	7,797	7,473	7,473
24°F	8,895	8,895	8,818	8,818	8,685	8,685	8,365	8,365
32°F	9,932	9,932	9,855	9,855	9,722	9,722	9,402	9,402
41°F	11,117	11,117	11,041	11,041	10,911	10,911	10,587	10,587
43°F	11,415	11,415	11,338	11,338	11,205	11,205	10,885	10,885
47°F	12,448	12,448	12,322	12,322	12,109	12,109	11,582	11,582
53°F	12,574	12,574	12,444	12,444	12,227	12,227	11,697	11,697
59°F	12,860	12,860	12,730	12,730	12,505	12,505	11,964	11,964
64°F	13,134	13,134	13,001	13,001	12,772	12,772	12,219	12,219
70°F	13,382	13,382	13,245	13,245	13,016	13,016	12,452	12,452
75°F	13,569	13,569	13,431	13,431	13,195	13,195	12,623	12,623

\* Maximum system capacity

TC- Total Capacity ( BtuH)  
SHC- Sensible Capacity (BtuH)



MINIMUM SPACING REQUIREMENTS

Units: inch (mm)

INDOOR

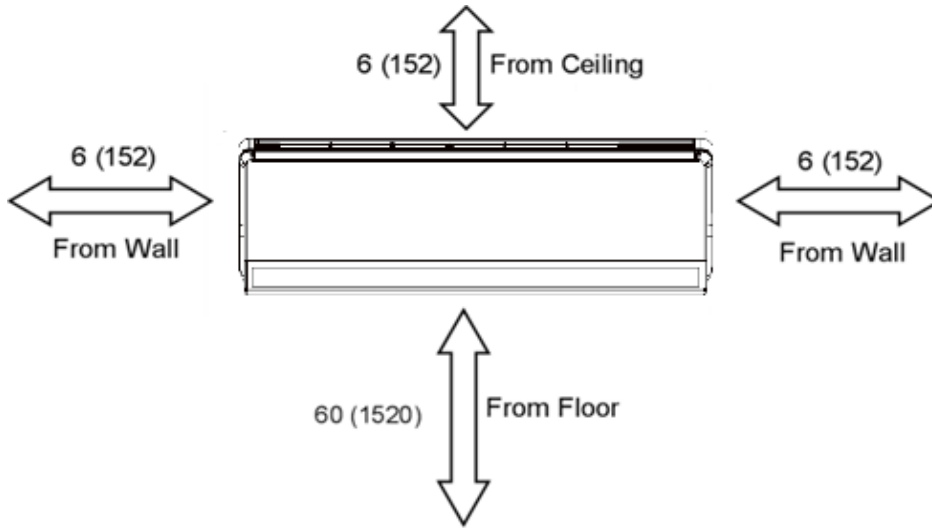

Units: inch (mm)

OUTDOOR

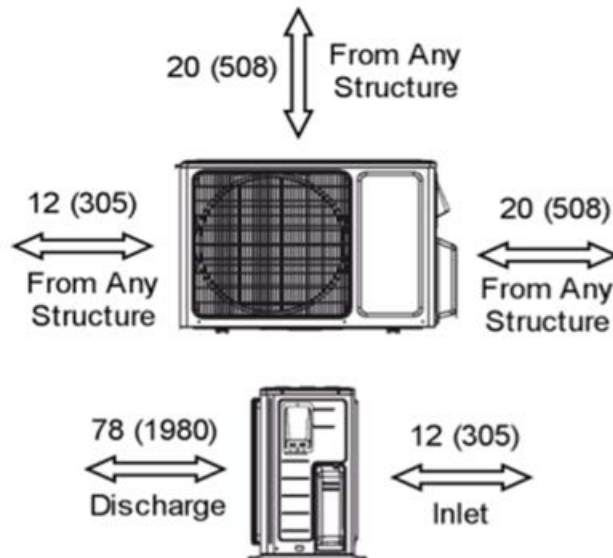

## DIMENSIONAL SPECIFICATIONS

VIR12HP115V1A

### INDOOR UNIT DIMENSIONS

Units: inch

Model No: VIR12HP115V1AH

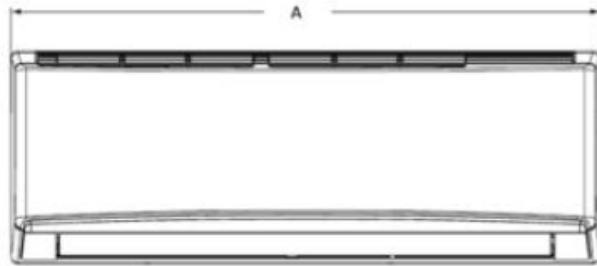

Dimensions	
A	33.4
B	11.4
C	8.2

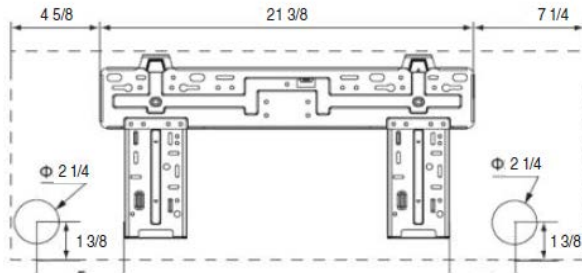

Weight (Net/Gross) 23.2/27.6 lbs

Liquid Line Valve	1/4-in OD Flared
Gas Line Valve	1/2-in OD Flared
Drain Connector	5/8-in OD

### OUTDOOR UNIT DIMENSIONS

Units: inch

Model No: VIR12HP115V1AO

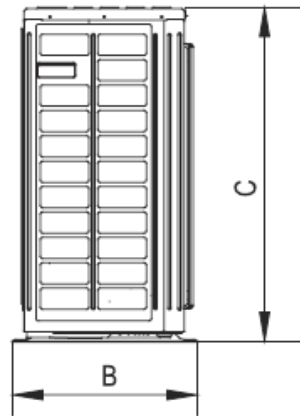
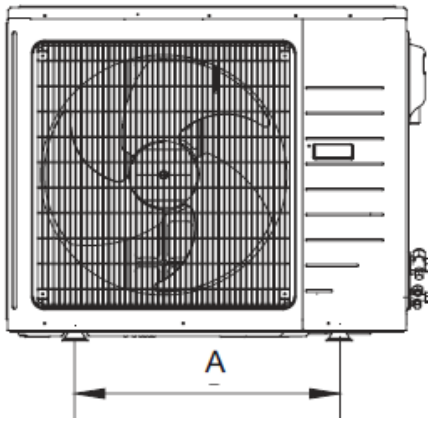

Dimensions	
A	21.3
B	11.3
C	21.3
D	33.4
D	12.6

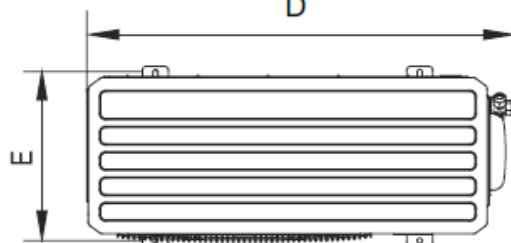

Weight (Net/Gross) 77.2/83.8 lbs

Liquid Line Valve	1/4-in OD Flared
Gas Line Valve	1/2-in OD Flared

**Notes:**

1. Recommended Interconnecting Cable Type 14 AWG 4 Stranded Bare Copper Conductors THHN 600V Wire
2. Power wiring cable size must comply with applicable national and local codes.
3. Test conditions are based on AHRI 210/240.



Specifications are subject to change without notice. Manufacturer reserves the right to discontinue or modify specifications or designs without notice or without incurring obligations. All rights reserved.